

MPAX PERSONALITY MODULE SELECTOR GUIDE FOR LPAX

Our large displays have various input options, determined by the installation of a MPAX personality module. These MPAX modules are based on standard PAX panel meters, and use the same data sheet as the PAX meter for specifications and wiring.

About the MPAX Input Modules

The MPAX Module serves as the input to the LPAX Display. There are several different modules to cover a variety of inputs. The MPAX module provides input scaling which allows the LPAX to display most any engineering unit. Once the MPAX is inserted into the LPAX, the unit has the same functions and capabilities of our PAX Series Intelligent Panel Meters. A full set of PAX programming instructions will be included with the MPAX Module.

Note: The MPAX provides the operating power for the LPAX, therefore you must select either the AC or DC MPAX corresponding with your application and available power.

Selecting Your Display Components

To build a complete display unit, you will need an LPAX and an MPAX Input Module. The LPAX is only a display and will not operate without an MPAX Module. Please use the following chart to identify the appropriate MPAX Module (including supply power) and LPAX Display that will satisfy your application.

MPAX Modules for LPAX5 (Analog units)

SIGNAL TYPE	INPUT RANGES	MPAX MODULES *		LPAX DISPLAYS
		85-250 VAC	11 to 36 VDC/ 24 VAC	
Universal DC Inputs	DC Voltage 200 mV, 2 V, 20 V, 300 V DC Current 200 μ A, 2 mA, 20 mA, 200 mA, 2 Amp Resistance 100 ohm, 1000 ohm, 10 K ohm	MPAXD000	MPAXD010	LPAX0500
Process Inputs	0-20 mA or 0-10 VDC	MPAXP000	MPAXP010	LPAX0500
Temperature Inputs	Thermocouples -T, E, J, K, R, S, B, N, C, or Custom Scaling RTDs - 100 ohm Pt (platinum) 385/392, 120 ohm Nickel 672, or 10 ohm Copper 427	MPAXT000	MPAXT010	LPAX0500
Strain Gage/Load Cell	24 mV or 240 mV	MPAXS000	MPAXS010	LPAX0500
True RMS AC Voltage/Current	AC Voltage 200 mV, 2 V, 20 V, 300 V AC Current 200 μ A, 2 mA, 20 mA, 200 mA, 5 Amp	MPAXH000	N/A	LPAX0500

MPAX Modules for LPAX6 (Digital units)

SIGNAL TYPE	MPAX MODULES*		LPAX DISPLAYS	OPTIONAL PLUG-IN CARD COMPATIBILITY			
	85-250 VAC	11 to 36 VDC / 24 VAC		SETPOINT	COMMS	ANALOG	REAL-TIME CLOCK
Count/Rate/Serial Slave	MPAXI000†	MPAXI010†	LPAX0600	YES	YES	YES	-
Count	MPAXC000	MPAXC010	LPAX0600	YES	-	-	-
Rate	MPAXR000	MPAXR010	LPAX0600	YES	-	-	-
Clock/Timer	MPAXCK00††	MPAXCK10††	LPAXCK00**	YES	YES	-	YES
Timer	MPAXTM00††	MPAXTM10††	LPAXCK00**	YES	YES	-	-

MPAX Modules for LPAXDA (Dual Analog Unit)

SIGNAL TYPE	INPUT RANGES	MPAX MODULES *		LPAX DISPLAY
		85-250 VAC	11 to 36 VDC/ 24 VAC	
Dual Process Inputs	0-20 mA or 0-10 VDC	MPAXDP00	MPAXDP10	LPAXDA00

MODEL LPAX- 6 DIGIT LARGE PAX DISPLAY FOR DIGITAL INPUTS





- LARGE LED DISPLAY READABLE TO 70 FEET
- VARIOUS DIGITAL INPUT MODULES;
 COUNT AND RATE INPUT
 CLOCK/TIMER
 SERIAL SLAVE
- ALARMS, ANALOG OUTPUT, AND COMMUNICATION
- PROGRAMMABLE USER INPUTS
- PROGRAMMABLE FUNCTION KEYS
- UNIVERSAL AC/DC POWERED MODELS
- PC SOFTWARE FOR METER CONFIGURATION
- NEMA 4/IP65

GENERAL DESCRIPTION

The LPAX Display is a versatile display that can increase productivity by offering the plant floor or production area a large visual display of their current status. Whether your measurement is rate, count, or time, the LPAX can satisfy your requirement. These LPAX displays accept various digital inputs through the use of input modules (MPAX) which allow the unit to adapt to most any application. The MPAX Modules offer the same features as our highly successful PAX Series Panel Meters. Additional plug-in option cards can add alarms, analog output, and communication/bus capabilities, making the LPAX a truly Intelligent Panel Meter.

SAFETY SUMMARY

All safety regulations, local codes and instructions that appear in this and corresponding literature, or on equipment, must be observed to ensure personal safety and to prevent damage to either the instrument or equipment connected to it. If equipment is used in a manner not specified by the manufacturer, the protection provided by the equipment may be impaired.

  The protective conductor terminal is bonded to conductive parts of the equipment for safety purposes and must be connected to an external protective earthing system.



CAUTION: Risk of Danger.
Read complete instructions prior to installation and operation of the unit.



CAUTION: Risk of electric shock.

SPECIFICATIONS

Additional specifications, wiring, programming, and information for the individual MPAX models are contained in the corresponding standard PAX literature. This PAX literature is shipped with the ordered MPAX model.

1. **DISPLAY:** 1.5" (38 mm) Red LED
 6-Digit (LPAX0600): (-99999 to 999999)
 6-Digit (LPAXCK00): (0 to 999999)
2. **POWER REQUIREMENTS:**
 AC Modules: 85 to 250 VAC, 50/60 Hz, 18 VA
 DC Modules: 11 to 36 VDC or 24 VAC ±10%, 50/60 Hz, 14 W
3. **INPUT:** Accepts digital input modules, see "Selecting Your Display Components and Option Cards."
4. **ANNUNCIATORS:**
 LPAX0600: A, B, C, SP1, SP2, SP3, and SP4
 LPAXCK00: TMR, CNT, DAT, SP1, SP2, SP3, and SP4
5. **KEYPAD:** Five tactile membrane switches integrated into the front panel
6. **CERTIFICATIONS AND COMPLIANCES:**

SAFETY

UL Recognized Component, File #E179259, UL61010A-1, CSA 22.2 No. 1010-1 Recognized to US and Canadian requirements under the Component Recognition Program of Underwriters Laboratories, Inc.
 UL Listed, File # E137808, UL508, CSA C22.2 No. 14-M95 LISTED by Und. Lab. Inc. to U.S and Canadian safety standards
 Type 4 Enclosure rating (Face Only), UL50
 IECCE CB Scheme Test Certificate # US/8843/UL
 CB Scheme Test Report # 04ME11209-20041018
 Issued by Underwriters Laboratories, Inc.
 IEC 61010-1, EN 61010-1: Safety requirements for electrical equipment for measurement, control, and laboratory use, Part 1.
 IP65 Enclosure rating (Face only), IEC 529

ELECTROMAGNETIC COMPATIBILITY

EMC specifications determined by the MPAX module.

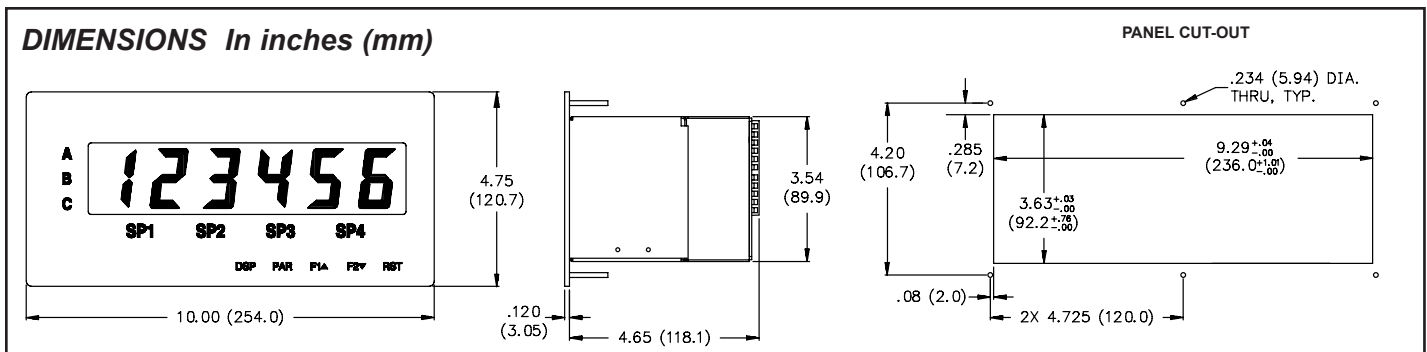

7. ENVIRONMENTAL CONDITIONS:

Operating Temperature Range: Determined by the MPAX module
 Storage Temperature Range: -40 to 60°C
 Operating and Storage Humidity: 0 to 85% max. RH (non-condensing)
 Altitude: Up to 2000 meters

8. MOUNTING REQUIREMENTS:

Max. panel thickness is 0.375" (9.5 mm)
 Min. panel thickness for NEMA 4/IP65 sealing is 0.060" (1.57 mm)

9. MODULE INSTALLATION:

24-pin shrouded connector on LPAX engages connector on MPAX module upon installation. Shroud ensures proper alignment by providing a lead-in for the module connector.

10. CONNECTIONS: All wiring connections are made to the MPAX module via high compression cage-clamp terminal blocks. Wiring instructions are provided with the MPAX module.



CAUTION: DISCONNECT ALL POWER BEFORE INSTALLING OR REMOVING MODULE

11. CONSTRUCTION: Steel front panel, enclosure, and rear cover with textured black polyurethane paint for scratch and corrosion resistance protection. Sealed front panel meets NEMA 4/IP65 specifications for indoor use when properly installed. Installation Category II, Pollution Degree 2. Panel gasket and keps nuts included.

12. WEIGHT: 2.7 lbs (1.2 kg) (*less module*)

About the MPAX Input Modules

The MPAX Module serves as the input to the LPAX Display. There are several different modules to cover a variety of inputs. The MPAX module provides input scaling which allows the LPAX to display most any engineering unit. Once the MPAX is inserted into the LPAX, the unit has the same functions and capabilities of our PAX Series Intelligent Panel Meters. A full set of PAX programming instructions will be included with the MPAX module.

Note: The MPAX provides the operating power for the LPAX, therefore you must select either the AC or DC MPAX corresponding with your application and available power.

Selecting Your Display Components and Option Cards

To build a complete display unit, you will need an LPAX and an MPAX Input Module. The LPAX is only a display and will not operate without an MPAX module. Please use the following chart to identify the appropriate MPAX module (including supply power) and LPAX Display that will satisfy your application.

SIGNAL TYPE	MPAX MODULES*		LPAX DISPLAYS	OPTIONAL PLUG-IN CARD COMPATABILITY			
	85-250 VAC	11 to 36 VDC / 24 VAC		SETPOINT	COMMS	ANALOG	REAL-TIME CLOCK
Count/Rate/Serial Slave	MPAXI000	MPAXI010	LPAX0600	YES	YES	YES	-
Count	MPAXC000	MPAXC010	LPAX0600	YES	-	-	-
Rate	MPAXR000	MPAXR010	LPAX0600	YES	-	-	-
Clock/Timer	MPAXCK00	MPAXCK10	LPAXCK00**	YES	YES	-	YES
Timer	MPAXTM00	MPAXTM10	LPAXCK00**	YES	YES	-	-

*For detailed module and plug-in card specifications, see corresponding PAX literature. (i.e. For MPAXI specifications, see the PAXI literature)

**The LPAXCK will only operate with the Clock/Timer MPAX input module.

OPTIONAL PLUG-IN CARDS AND ACCESSORIES



WARNING: Disconnect all power to the unit before installing Plug-in cards.

Adding Option Cards

The MPAX series meters can be fitted with up to three optional plug-in cards. However, only one card from each function type can be installed at a time. The function types include Setpoint Alarms (PAXCDS), Communications (PAXCDC), and Analog Output (PAXCDL). The cards can be installed initially or at a later date. Each optional plug-in card is shipped with installation and programming instructions.

COMMUNICATION CARDS (PAXCDC)

A variety of communication protocols are available for the PAX and MPAX series. Only one of these cards can be installed at a time. When programming the unit via Crimson (for MPAXI) or SFPAX (for MPAXCK or MPAXTM), the RS232 or RS485 Cards must be used.

- PAXCDC10 - RS485 Serial (Terminal) PAXCDC30 - DeviceNet
- PAXCDC1C - RS485 Serial (Connector) PAXCDC40 - Modbus (Terminal)
- PAXCDC20 - RS232 Serial (Terminal) PAXCDC4C - Modbus (Connector)
- PAXCDC2C - RS232 Serial (Connector) PAXCDC50 - Profibus-DP

SETPOINT CARDS (PAXCDS)

The MPAX series has four setpoint alarm output plug-in cards. Only one of these cards can be installed at a time. (Logic state of the outputs can be reversed in the programming.) These plug-in cards include:

- Dual relay, FORM-C, Normally open & closed
- Quad relay, FORM-A, Normally open only
- Isolated quad sinking NPN open collector
- Isolated quad sourcing PNP open collector

LINEAR DC OUTPUT (PAXCDL)

Either a 0(4)-20 mA or 0-10 V retransmitted linear DC output is available from the analog output plug-in card. The programmable output low and high scaling can be based on the input, max, min, or total display value. Reverse slope output is possible by reversing the scaling point positions.

PAXCDL10 - Retransmitted Analog Output Card

PROGRAMMING SOFTWARE

CRIMSON - MPAXI Only

Crimson is a Windows® based program that allows configuration of the LPAX meter from a PC. Crimson offers standard drop-down menu commands, that make it easy to program the LPAX meter. The LPAX program can then be saved in a PC file for future use. A PAX serial plug-in card is required to program the meter using the software.

SFPAX - MPAXCK and MPAXTM Only

The SFPAX is a Windows® based program that allows configuration of the LPAX meter from a PC. Using the SFPAX makes it easier to program the LPAX meter and allows saving the PAX program in a PC file for future use. On-line help is available within the software. A PAX serial plug-in card is required to program the meter using the software.

1.0 ASSEMBLING THE DISPLAY



CAUTION: The MPAX main circuit board and the option cards contain static sensitive components. Before handling the module or the cards, discharge static charges from your body by touching a grounded bare metal object. Handle the module by the rear plastic cover only, and the option cards by the board edges. Dirt, oil or other contaminants that contact the circuit boards or components can adversely affect circuit operation.



WARNING: Exposed line voltage exists on the MPAX main circuit board and the option cards. **DO NOT** apply power to the module OR load circuits until the module is properly installed in the LPAX case.



NOTE: All module and option card labels must be installed as shown for safety purposes.

Prior to installing the LPAX Display, it is recommended that the MPAX and any option cards be assembled first. This will allow you the opportunity to insure all the boards are fitted properly into their connectors.

Installing the Option Cards

If your application requires option cards, they should be installed into the MPAX before it is installed into the LPAX Display. Refer to the literature enclosed with the option cards for installation instruction.

Installing the MPAX

To install the MPAX Module, align the module with the opening in the LPAX case, as illustrated. The module must be oriented as shown, with terminal #1 toward the top of the LPAX case. Carefully slide the module into the LPAX case.

The LPAX and MPAX connectors will begin to engage about 1/4" from the bottom. At this point, apply a small amount of pressure to the rear of the MPAX module to fully engage the connection. Be sure the module fully snaps into the slots at the rear of the LPAX case. The display is ready for installation.

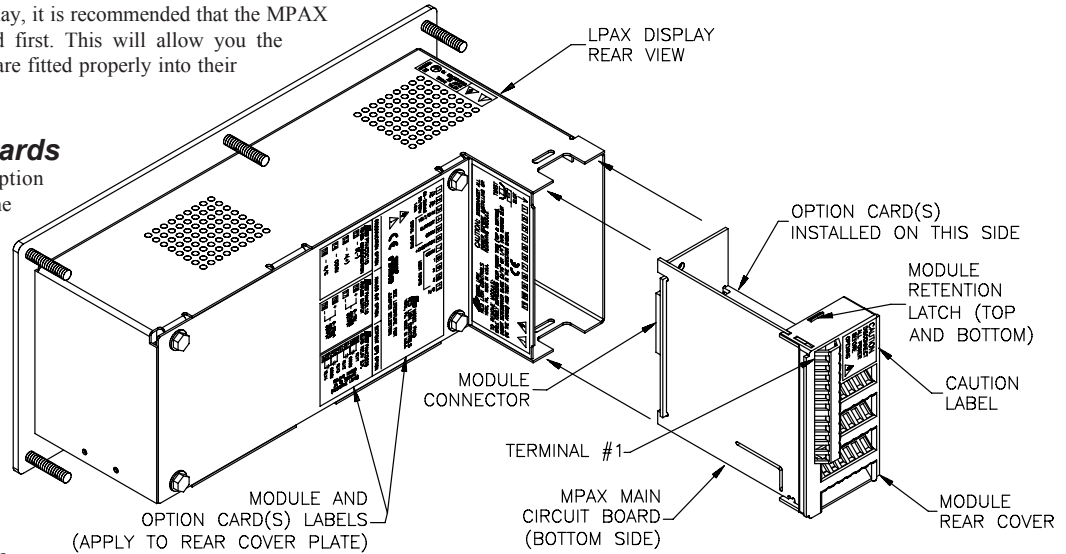

Figure 1, Installing an MPAX Module and Option Cards

Installing the Labels

Each option card and the MPAX are shipped with a connection label. These labels must be applied to the rear of the LPAX in the positions shown in the drawing.

Removing The MPAX Module

To remove the MPAX Module from the LPAX Display, first remove all power and load circuits. Then insert a flat screwdriver blade (3/16" or 1/4") into the narrow slot between the LPAX rear cover plate and the module's plastic cover as illustrated in Figure 2. Twist the screwdriver in the direction shown to disengage the internal connectors while firmly squeezing and pulling back on the rear finger tabs (top and bottom). Carefully slide the module out of the LPAX case, keeping it properly aligned with the case opening.

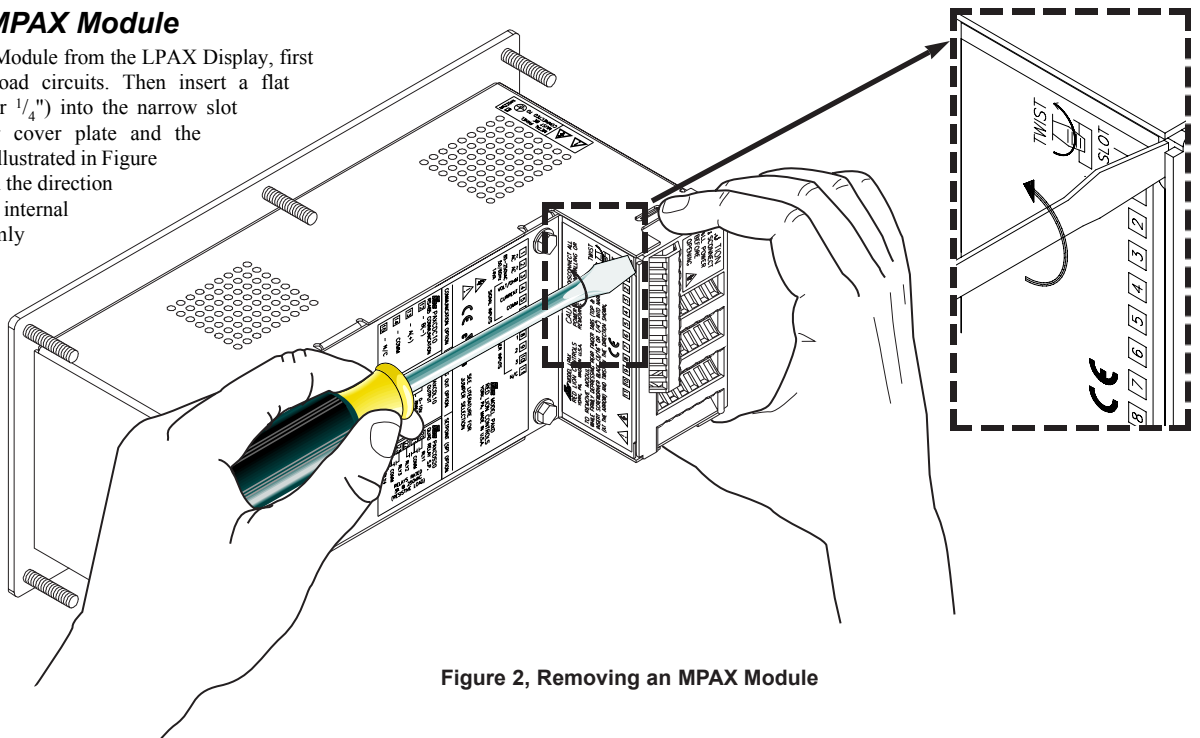

Figure 2, Removing an MPAX Module

2.0 INSTALLING THE DISPLAY

LPAX DISPLAY INSTALLATION

The LPAX display is intended to be mounted into a panel or enclosure. The display is provided with a gasket to provide a water-tight seal. The recommended minimum panel thickness for NEMA 4/IP65 sealing is 0.060" (1.57 mm).

For panel mounting, prepare the panel cut-out to the dimensions shown. The supplied template may be used to mark the cut-out and hole locations on the panel. After the panel cut-out has been deburred, slide the panel gasket over the rear of the display and onto the mounting studs. Insert the display into the panel cut-out as illustrated in Figure 3. Install six # 10-32 keps nuts (supplied) and tighten evenly for uniform gasket compression. Do not over-tighten the nuts.

By using additional mounting accessories, the LPAX can be surface-wall mounted, suspended, or bottom mounted. Separate installation instructions are provided with the mounting accessories.

Environment And Cleaning

The display should be installed in a location that does not exceed the maximum operating temperature and provides good air circulation. Placing the system near devices that generate excessive heat should be avoided.

The bezel should be cleaned only with a soft cloth and neutral soap product. Do NOT use solvents. Continuous exposure to direct sunlight may accelerate the aging process of the bezel.

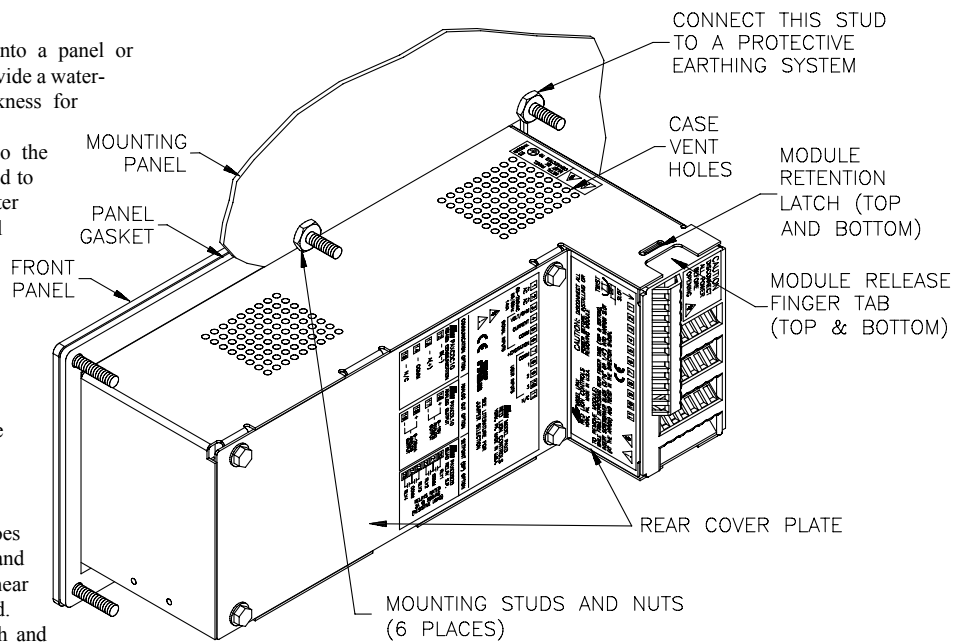

Figure 3, Installing The LPAX Into A Panel

3.0 WIRING AND PROGRAMMING THE DISPLAY

Once assembled, the LPAX and MPAX have all the same functions and capabilities of our PAX Series Intelligent Panel Meters. Therefore, you will find the appropriate PAX information packed with the MPAX Module. Simply follow the instructions to wire and program the display for your application.

TROUBLESHOOTING

For technical assistance, contact technical support.

ORDERING INFORMATION

TYPE	MODEL NO.	DESCRIPTION	PART NUMBERS		
Display	LPAX	6-Digit Display for Digital MPAX Modules	LPAX0600		
		6-Digit Display for MPAXCK (Clock/Timer) and MPAXTM Only	LPAXCK00		
Digital Input Module	MPAX	Count/Rate Indicator Module, AC Powered	MPAXI000		
		Count/Rate Indicator Module, DC/24 VAC Powered	MPAXI010		
		Count Indicator Module, AC Powered	MPAXC000		
		Count Indicator Module, DC/24 VAC Powered	MPAXC010		
		Rate Indicator Module, AC Powered	MPAXR000		
		Rate Indicator Module, DC/24 VAC Powered	MPAXR010		
		Clock/Timer Module, AC Powered	MPAXCK00		
		Clock/Timer Module, DC/24 VAC Powered	MPAXCK10		
		Timer Module, AC Powered	MPAXTM00		
		Timer Module, DC/24 VAC Powered	MPAXTM10		
		Optional Plug-In Cards	PAXCDS	Dual Setpoint Relay Output Card	PAXCDS10
				Quad Setpoint Relay Output Card	PAXCDS20
Quad Setpoint Sinking Open Collector Output Card	PAXCDS30				
Quad Setpoint Sourcing Open Collector Output Card	PAXCDS40				
PAXCDC*	RS485 Serial Communications Output Card with Terminal Block		PAXCDC10		
	Extended RS485 Serial Communications Output Card with Dual RJ11 Connector		PAXCDC1C		
	RS232 Serial Communications Output Card with Terminal Block		PAXCDC20		
	Extended RS232 Serial Communications Output Card with 9 Pin D Connector		PAXCDC2C		
	DeviceNet Communications Card		PAXCDC30		
	Modbus Communications Card		PAXCDC40		
	Extended Modbus Communications Card with Dual RJ11 Connector		PAXCDC4C		
	Profibus-DP Communications Card		PAXCDC50		
PAXCDL*	Analog Output Card		PAXCDL10		
PAXRTC*	Real Time Clock Card for MPAXCK (Clock/Timer) Only		PAXRTC00		
Accessories	SFCRD**		Crimson 2 PC Configuration Software for Windows 98, ME, 2000 and XP (for MPAXI)	SFCRD200	
	SFPAX**		PC Configuration Software for Windows 95/98 on 3.5" disk (for MPAXCK and MPAXTM)	SFPAX	
	ENC9	NEMA 4 Enclosure for LPAX	ENC90000		
	SHR	Shroud for LPAX	SHRPLAX0		
	MB	Mounting Bracket for LPAX	MBLPAX00		

*Refer to "Selecting Your Display Components and Option Cards."

**Available as a FREE download from the Red Lion website. www.redlion.net

MODEL PAX - 1/8 DIN DIGITAL INPUT PANEL METERS



- COUNT, DUAL COUNTER, RATE AND SLAVE DISPLAY
- 0.56" RED SUNLIGHT READABLE DISPLAY
- VARIABLE INTENSITY DISPLAY
- 10 POINT SCALING FOR NON-LINEAR PROCESSES (PAXI)
- FOUR SETPOINT ALARM OUTPUTS (W/Option Card)
- RETRANSMITTED ANALOG OUTPUT (W/Option Card) (PAXI)
- COMMUNICATION AND BUS CAPABILITIES (W/Option Card) (PAXI)
- BUS CAPABILITIES; DEVICENET, MODBUS, AND PROFIBUS-DP
- CRIMSON PROGRAMMING SOFTWARE (PAXI)
- ETHERNET(W/ External Gateway) (PAXI)
- NEMA 4X/IP65 SEALED FRONT BEZEL



GENERAL DESCRIPTION

The PAX Digital Input Panel Meters offer many features and performance capabilities to suit a wide range of industrial applications. Available in three different models, PAXC Counter/Dual Counter, PAXR Rate Meter and the PAXI which offers both counting and rate in the same package. Refer to pages 4 - 5 for the details on the specific models. The PAXC and PAXR offer only the Setpoint Option, while the PAXI is the fully featured version offering all the capabilities as outlined in this bulletin as well as a slave display feature. The optional plug-in output cards allow the opportunity to configure the meter for present applications, while providing easy upgrades for future needs.

The meters employ a bright 0.56" LED display. The meters are available with a red sunlight readable or standard green LED display. The intensity of the display can be adjusted from dark room applications up to sunlight readable, making it ideal for viewing in bright light applications.

The meters accept digital inputs from a variety of sources including switch contacts, outputs from CMOS or TTL circuits, magnetic pickups and all standard RLC sensors. The meter can accept directional, uni-directional or Quadrature signals simultaneously. The maximum input signal varies up to 34 KHz depending on the count mode and function configurations programmed. Each input signal can be independently scaled to various process values.

The Rate Meters provide a MAX and MIN reading memory with programmable capture time. The capture time is used to prevent detection of false max or min readings which may occur during start-up or unusual process events.

The meters have four setpoint outputs, implemented on Plug-in option cards. The Plug-in cards provide dual FORM-C relays (5A), quad FORM-A (3A), or either quad sinking or quad sourcing open collector logic outputs. The setpoint alarms can be configured to suit a variety of control and alarm requirements.

Communication and Bus Capabilities are also available as option cards for the PAXI only. These include RS232, RS485, Modbus, DeviceNet, and Profibus-DP. Readout values and setpoint alarm values can be controlled

through the bus. Additionally, the meters have a feature that allows a remote computer to directly control the outputs of the meter. With an RS232 or RS485 card installed, it is possible to configure the meter using Red Lion's Crimson software. The configuration data can be saved to a file for later recall.

A linear DC output signal is available as an optional Plug-in card for the PAXI only. The card provides either 20 mA or 10 V signals. The output can be scaled independent of the input range and can track any of the counter or rate displays.

Once the meters have been initially configured, the parameter list may be locked out from further modification in its entirety or only the setpoint values can be made accessible.

The meters have been specifically designed for harsh industrial environments. With NEMA 4X/IP65 sealed bezel and extensive testing of noise effects to CE requirements, the meter provides a tough yet reliable application solution.

SAFETY SUMMARY

All safety related regulations, local codes and instructions that appear in this literature or on equipment must be observed to ensure personal safety and to prevent damage to either the instrument or equipment connected to it. If equipment is used in a manner not specified by the manufacturer, the protection provided by the equipment may be impaired.

Do not use this meter to directly command motors, valves, or other actuators not equipped with safeguards. To do so can be potentially harmful to persons or equipment in the event of a fault to the meter.



CAUTION: Risk of Danger.
 Read complete instructions prior to installation and operation of the unit.



CAUTION: Risk of electric shock.

DIMENSIONS In inches (mm)

Note: Recommended minimum clearance (behind the panel) for mounting clip installation is 2.1" (53.4) H x 5" (127) W.

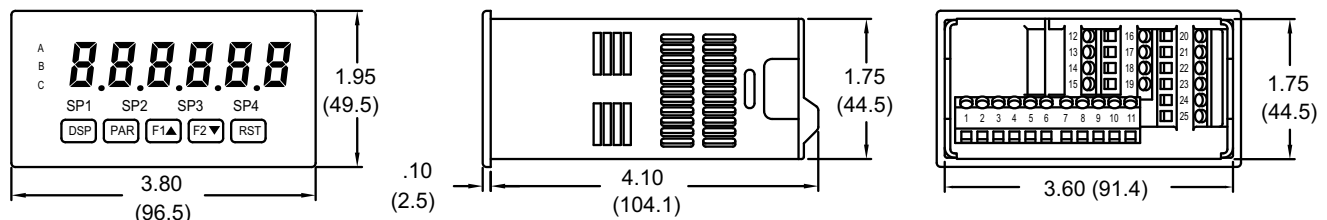
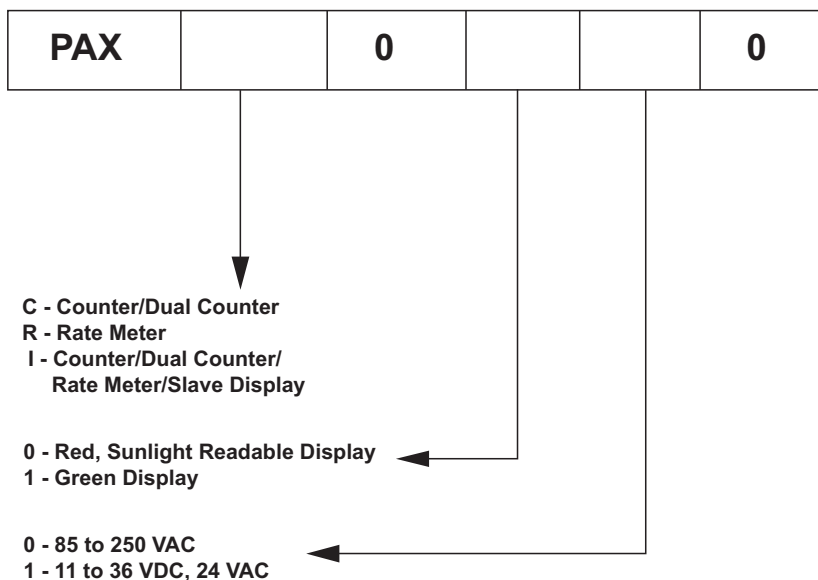

TABLE OF CONTENTS

Ordering Information	2	Installing Plug-In Cards	8
General Meter Specifications	3	Wiring the Meter	9
PAXC Counter	4	Reviewing the Front Buttons and Display . . .	11
PAXR Rate Meter	4	Programming the Meter	12
PAXI Counter/Rate Meter	5	Factory Service Operations	28
Optional Plug-In Output Cards	6	Troubleshooting	29
Installing the Meter	7	Parameter Value Chart	30
Setting the Jumper and DIP Switches	7	Programming Overview	32

ORDERING INFORMATION

Meter Part Numbers



Option Card and Accessories Part Numbers

TYPE	MODEL NO.	DESCRIPTION	PART NUMBER
Optional Plug-In Cards	PAXCDS	Dual Setpoint Relay Output Card	PAXCDS10
		Quad Setpoint Relay Output Card	PAXCDS20
		Quad Setpoint Sinking Open Collector Output Card	PAXCDS30
		Quad Setpoint Sourcing Open Collector Output Card	PAXCDS40
	PAXCDC	RS485 Serial Communications Card with Terminal Block	PAXCDC10
		Extended RS485 Serial Communications Card with Dual RJ11 Connector	PAXCDC1C
		RS232 Serial Communications Card with Terminal Block	PAXCDC20
		Extended RS232 Serial Communications Card with 9 Pin D Connector	PAXCDC2C
		DeviceNet Communications Card	PAXCDC30
		Modbus Communications Card	PAXCDC40
		Extended Modbus Communications Card with Dual RJ11 Connector	PAXCDC4C
		Profibus-DP Communications Card	PAXCDC50
	PAXUSB	PAX USB Programming Card (Not included in PAX product UL E179259 file).	PAXUSB00
	PAXCDL	Analog Output Card	PAXCDL10
Accessories	SFCRD*	Crimson PC Configuration Software for Windows 98, ME, 2000 and XP	SFCRD200
	ICM8	Communication Gateway	ICM80000

*Crimson software is available for free download from <http://www.redlion.net/>

Shaded areas are only available for the PAXI

MODEL PAXC - 1/8 DIN COUNTER

- 6-DIGIT LED DISPLAY (Alternating 8 digits for counting)
- DUAL COUNT QUAD INPUTS
- UP TO 3 COUNT DISPLAYS
- SETPOINT ALARM OUTPUTS (W/Plug-in card)

PAXC SPECIFICATIONS

MAXIMUM SIGNAL FREQUENCIES:

To determine the maximum frequency for the input(s), first answer the questions with a yes (Y) or no (N). Next determine the Count Mode to be used for the counter(s). If dual counters are used with different Count Modes, then the lowest frequency applies to both counters.

FUNCTION QUESTIONS	Single: Counter A or B				Dual: Counter A & B			
	N	N	Y	Y	N	N	Y	Y
Are any setpoints used?	N	N	Y	Y	N	N	Y	Y
Is Counter C used?	N	Y	N	Y	N	Y	N	Y
COUNT MODE	(Values are in KHz)				(Values are in KHz)			
Count x1	34	25	18	15	13	12	9	7.5
Count x2	17	13	9	7	9	7	5	4
Quadrature x1	22	19	12	10	7	6	4	3.5
Quadrature x2	17	13	9	7	7	6	4	3.5
Quadrature x4	8	6	4	3				

Notes:

1. Counter Modes are explained in the Module 1 programming section.
2. Listed values are with frequency DIP switch set on HI frequency.

ANNUNCIATORS:

- A - Counter A
- B - Counter B
- C - Counter C
- BF** - Upper significant digit display of counter
- SP1 - setpoint 1 output state
- SP2 - setpoint 2 output state
- SP3 - setpoint 3 output state
- SP4 - setpoint 4 output state

COUNTER DISPLAYS:

Maximum display: 8 digits: ± 99999999 (greater than 6 digits display Alternates between high order and low order.)

INPUTS A and B:

DIP switch selectable to accept pulses from a variety of sources including switch contacts, TTL outputs, magnetic pickups and all standard RLC sensors.

LOGIC: Input trigger levels $V_{IL} = 1.5 \text{ V max.}$; $V_{IH} = 3.75 \text{ V min.}$

Current sinking: Internal 7.8 K Ω pull-up to +12 VDC, $I_{MAX} = 1.9 \text{ mA.}$

Current sourcing: Internal 3.9 K Ω pull-down, 7.3 mA max. @ 28 VDC, $V_{MAX} = 30 \text{ VDC.}$

Filter: Damping capacitor provided for switch contact bounce. Limits input frequency to 50 Hz and input pulse widths to 10 msec. minimum.

DUAL COUNT MODES:

When any dual count mode is used, then User Inputs 1 and/or 2 will accept the second signal of each signal pair. The user inputs do not have the Logic/Mag, HI/LO Freq, and Sink/Source input setup switches. The user inputs are inherently a logic input with no low frequency filtering. Any mechanical contacts used for these inputs in a dual count mode must be debounced externally. The user input may only be selected for sink/source by the User Jumper placement.

MODEL PAXR - 1/8 DIN RATE METER

- 5-DIGIT LED DISPLAY
- RATE INDICATION
- MINIMUM/MAXIMUM RATE DISPLAYS
- SETPOINT ALARM OUTPUTS (W/Plug-in card)

PAXR SPECIFICATIONS

ANNUNCIATORS:

- r** - Rate
- H** - Maximum (High) Rate
- L** - Minimum (Low) Rate
- SP1 - setpoint 1 output state
- SP2 - setpoint 2 output state
- SP3 - setpoint 3 output state
- SP4 - setpoint 4 output state

RATE DISPLAY:

Accuracy: ±0.01%
 Minimum Frequency: 0.01 Hz
 Maximum Frequency: 34 KHz
 Maximum Display: 5 Digits: 99999
 Adjustable Display (low) Update: 0.1 to 99.9 seconds
 Over Range Display: "r **DLDL**"

INPUT A:

DIP switch selectable to accept pulses from a variety of sources including TTL outputs, magnetic pickups and all standard RLC sensors.

LOGIC: Input trigger levels $V_{IL} = 1.5 \text{ V max.}$; $V_{IH} = 3.75 \text{ V min.}$

Current sinking: Internal 7.8 K Ω pull-up to +12 VDC, $I_{MAX} = 1.9 \text{ mA.}$

Current sourcing: Internal 3.9 K Ω pull-down, 7.3 mA max. @ 28 VDC, $V_{MAX} = 30 \text{ VDC.}$

MAGNETIC PICKUP:

Sensitivity: 200 mV peak

Hysteresis: 100 mV

Input impedance: 3.9 K Ω @ 60 Hz

Maximum input voltage: ±40 V peak, 30 Vrms

MODEL PAXI - 1/8 DIN COUNTER/RATE METER

- COUNT, RATE AND SLAVE DISPLAY
- 6-DIGIT 0.56" RED SUNLIGHT READABLE DISPLAY
- VARIABLE INTENSITY DISPLAY
- 10 POINT SCALING (FOR NON-LINEAR PROCESSES)
- FOUR SETPOINT ALARM OUTPUTS (W/OPTION CARD)
- RETRANSMITTED ANALOG OUTPUT (W/OPTION CARD)
- COMMUNICATION AND BUS CAPABILITIES (W/OPTION CARD)
- BUS CAPABILITIES; DEVICENET, MODBUS, AND PROFIBUS-DP
- CRIMSON PROGRAMMING SOFTWARE

PAXI SPECIFICATIONS

MAXIMUM SIGNAL FREQUENCIES TABLE

To determine the maximum frequency for the input(s), first answer the questions with a yes (Y) or no (N). Next determine the Count Mode to be used for the counter(s). If dual counters are used with different Count Modes, then the lowest frequency applies to both counters.

FUNCTION QUESTIONS	Single: Counter A or B (with/without rate) or Rate only								Dual: Counter A & B or Rate not assigned to active single counter							
Are any setpoints used?	N	N	N	N	Y	Y	Y	Y	N	N	N	N	Y	Y	Y	Y
Is Prescaler Output used?	N	N	Y	Y	N	N	Y	Y	N	N	Y	Y	N	N	Y	Y
Is Counter C used?	N	Y	N	Y	N	Y	N	Y	N	Y	N	Y	N	Y	N	Y
COUNT MODE	(Values are in KHz)				(Values are in KHz)				(Values are in KHz)				(Values are in KHz)			
Count x1	34	25	21	17	18	15	13	11	13	12	13	11	9	7.5	9	7
Count x2	17	13	16	12	9	7	8	7	9*	7*	9*	7*	5*	4*	5*	4*
Quadrature x1	22	19	20	17	12	10	11	10	7*	6*	6*	5*	4*	3.5*	3.5*	3*
Quadrature x2	17	13	16	12	9	7	8	6	7*	6*	6*	5*	4*	3.5*	3.5*	3*
Quadrature x4	8	6	8	6	4	3	4	3								
Rate Only	34	N/A	21	N/A	34	N/A	21	N/A								

Notes:

1. Counter Modes are explained in the Module 1 programming section.
2. If using Rate with single counter with direction or quadrature, assign it to Input A for the listed frequency.
3. * Double the listed value for Rate frequency.
4. Listed values are with frequency DIP switch set on HI frequency.
5. Derate listed frequencies by 20% during serial communications. (Placing a 5 msec. delay between serial characters will eliminate the derating.)

ANNUNCIATORS:

- A - Counter A
- B - Counter B
- C - Counter C
- r - Rate
- H - Maximum (High) Rate
- L - Minimum (Low) Rate
- BF - Upper significant digit display of counter
- SP1 - setpoint 1 output state
- SP2 - setpoint 2 output state
- SP3 - setpoint 3 output state
- SP4 - setpoint 4 output state

RATE DISPLAY:

- Accuracy: $\pm 0.01\%$
- Minimum Frequency: 0.01 Hz
- Maximum Frequency: see Max Signal Frequencies Table.
- Maximum Display: 5 Digits: 99999
- Adjustable Display (low) Update: 0.1 to 99.9 seconds
- Over Range Display: "r BLBL"

COUNTER DISPLAYS:

- Maximum display: 8 digits: ± 99999999 (greater than 6 digits display
- Alternates between high order and low order.)

INPUTS A and B:

DIP switch selectable to accept pulses from a variety of sources including switch contacts, TTL outputs, magnetic pickups and all standard RLC sensors.

LOGIC: Input trigger levels $V_{IL} = 1.5$ V max.; $V_{IH} = 3.75$ V min.

Current sinking: Internal 7.8 K Ω pull-up to +12 VDC, $I_{MAX} = 1.9$ mA.

Current sourcing: Internal 3.9 K Ω pull-down, 7.3 mA max. @ 28 VDC, $V_{MAX} = 30$ VDC.

Filter: Damping capacitor provided for switch contact bounce. Limits input frequency to 50 Hz and input pulse widths to 10 msec. minimum.

MAGNETIC PICKUP:

Sensitivity: 200 mV peak

Hysteresis: 100 mV

Input impedance: 3.9 K Ω @ 60 Hz

Maximum input voltage: ± 40 V peak, 30 Vrms

DUAL COUNT MODES:

When any dual count mode is used, then User Inputs 1 and/or 2 will accept the second signal of each signal pair. The user inputs do not have the Logic/Mag, HI/LO Freq, and Sink/Source input setup switches. The user inputs are inherently a logic input with no low frequency filtering. Any mechanical contacts used for these inputs in a dual count mode must be debounced externally. The user input may only be selected for sink/source by the User Jumper placement.

PRESCALER OUTPUT:

NPN Open Collector: $I_{SNK} = 100$ mA max. @ $V_{OL} = 1$ VDC max. $V_{OH} = 30$ VDC max. With duty cycle of 25% min. and 50% max.

OPTIONAL PLUG-IN OUTPUT CARDS



WARNING: Disconnect all power to the unit before installing Plug-in cards.

Adding Option Cards

The PAX and MPAX series meters can be fitted with up to three optional plug-in cards. The details for each plug-in card can be reviewed in the specification section below. Only one card from each function type can be installed at one time. The function types include Setpoint Alarms (PAXCDS), Communications (PAXCDC), and Analog Output (PAXCDL). The plug-in cards can be installed initially or at a later date.

PAXI COMMUNICATION CARDS (PAXCDC)

A variety of communication protocols are available for the PAX and MPAX series. Only one of these cards can be installed at a time. When programming the unit via Crimson, a Windows® based program, the RS232 or RS485 Cards must be used.

PAXCDC10 - RS485 Serial (Terminal) PAXCDC30 - DeviceNet
PAXCDC1C - RS485 Serial (Connector) PAXCDC40 - Modbus (Terminal)
PAXCDC20 - RS232 Serial (Terminal) PAXCDC4C - Modbus (Connector)
PAXCDC2C - RS232 Serial (Connector) PAXCDC50 - Profibus-DP

SERIAL COMMUNICATIONS CARD

Type: RS485 or RS232
Isolation To Sensor & User Input Commons: 500 Vrms for 1 min.
Working Voltage: 50 V. Not Isolated from all other commons.
Data: 7/8 bits
Baud: 300 to 19,200
Parity: no, odd or even
Bus Address: Selectable 0 to 99, Max. 32 meters per line (RS485)
Transmit Delay: Selectable for 2 to 50 msec or 50 to 100 msec (RS485)

DEVICENET™ CARD

Compatibility: Group 2 Server Only, not UCMM capable
Baud Rates: 125 Kbaud, 250 Kbaud, and 500 Kbaud
Bus Interface: Phillips 82C250 or equivalent with MIS wiring protection per DeviceNet™ Volume I Section 10.2.2.
Node Isolation: Bus powered, isolated node
Host Isolation: 500 Vrms for 1 minute (50 V working) between DeviceNet™ and meter input common.

MODBUS CARD

Type: RS485; RTU and ASCII MODBUS modes
Isolation To Sensor & User Input Commons: 500 Vrms for 1 minute.
Working Voltage: 50 V. Not isolated from all other commons.
Baud Rates: 300 to 38400.
Data: 7/8 bits
Parity: No, Odd, or Even
Addresses: 1 to 247.
Transmit Delay: Programmable; See Transmit Delay explanation.

PROFIBUS-DP CARD

Fieldbus Type: Profibus-DP as per EN 50170, implemented with Siemens SPC3 ASIC
Conformance: PNO Certified Profibus-DP Slave Device
Baud Rates: Automatic baud rate detection in the range 9.6 Kbaud to 12 Mbaud
Station Address: 0 to 125, set by rotary switches.
Connection: 9-pin Female D-Sub connector
Network Isolation: 500 Vrms for 1 minute (50 V working) between Profibus network and sensor and user input commons. Not isolated from all other commons.

PROGRAMMING SOFTWARE

Crimson is a Windows® based program that allows configuration of the PAX meter from a PC. Crimson offers standard drop-down menu commands, that make it easy to program the PAX meter. The PAX program can then be saved in a PC file for future use. A PAX serial plug-in card or PAX USB programming card is required to program the meter using the software.

SETPOINT CARDS (PAXCDS)

The PAX and MPAX series has 4 available setpoint alarm output plug-in cards. Only one of these cards can be installed at a time. (Logic state of the outputs can be reversed in the programming.) These plug-in cards include:

PAXCDS10 - Dual Relay, FORM-C, Normally open & closed
PAXCDS20 - Quad Relay, FORM-A, Normally open only
PAXCDS30 - Isolated quad sinking NPN open collector
PAXCDS40 - Isolated quad sourcing PNP open collector

DUAL RELAY CARD

Type: Two FORM-C relays
Isolation To Sensor & User Input Commons: 2000 Vrms for 1 min.
Working Voltage: 240 Vrms
Contact Rating:
One Relay Energized: 5 amps @ 120/240 VAC or 28 VDC (resistive load),
1/8 HP @120 VAC, inductive load
Total current with both relays energized not to exceed 5 amps
Life Expectancy: 100 K cycles min. at full load rating. External RC snubber extends relay life for operation with inductive loads
Response Time: 5 msec. nominal pull-in with 3 msec. nominal release
Timed Output Accuracy: Counter = $\pm 0.01\% + 10$ msec.
Rate = $\pm 0.01\% + 20$ msec.

QUAD RELAY CARD

Type: Four FORM-A relays
Isolation To Sensor & User Input Commons: 2300 Vrms for 1 min.
Working Voltage: 250 Vrms
Contact Rating:
One Relay Energized: 3 amps @ 250 VAC or 30 VDC (resistive load), 1/10 HP @120 VAC, inductive load
Total current with all four relays energized not to exceed 4 amps
Life Expectancy: 100K cycles min. at full load rating. External RC snubber extends relay life for operation with inductive loads
Response Time: 5 msec. nominal pull-in with 3 msec. nominal release
Timed Output Accuracy: Counter = $\pm 0.01\% + 10$ msec.
Rate = $\pm 0.01\% + 20$ msec.

QUAD SINKING OPEN COLLECTOR CARD

Type: Four isolated sinking NPN transistors.
Isolation To Sensor & User Input Commons: 500 Vrms for 1 min.
Working Voltage: 50 V. Not Isolated from all other commons.
Rating: 100 mA max @ $V_{SAT} = 0.7$ V max. $V_{MAX} = 30$ V
Response Time: Counter = 25 μ sec; Rate = Low Update time
Timed Output Accuracy: Counter = $\pm 0.01\% + 10$ msec.
Rate = $\pm 0.01\% + 20$ msec.

QUAD SOURCING OPEN COLLECTOR CARD

Type: Four isolated sourcing PNP transistors.
Isolation To Sensor & User Input Commons: 500 Vrms for 1 min.
Working Voltage: 50 V. Not Isolated from all other commons.
Rating: Internal supply: 24 VDC $\pm 10\%$, 30 mA max. total
External supply: 30 VDC max., 100 mA max. each output
Response Time: Counter = 25 μ sec; Rate = Low Update time
Timed Output Accuracy: Counter = $\pm 0.01\% + 10$ msec.
Rate = $\pm 0.01\% + 20$ msec.

PAXI ANALOG OUTPUT CARD (PAXCDL)

Either a 0(4)-20 mA or 0-10 V retransmitted linear DC output is available from the analog output plug-in card. The programmable output low and high scaling can be based on various display values. Reverse slope output is possible by reversing the scaling point positions.

PAXCDL10 - Retransmitted Analog Output Card

ANALOG OUTPUT CARD

Types: 0 to 20 mA, 4 to 20 mA or 0 to 10 VDC
Isolation To Sensor & User Input Commons: 500 Vrms for 1 min.
Working Voltage: 50 V. Not Isolated from all other commons.
Accuracy: 0.17% of FS (18 to 28°C); 0.4% of FS (0 to 50°C)
Resolution: 1/3500
Compliance: 10 VDC: 10 K Ω load min., 20 mA: 500 Ω load max.
Response Time: 50 msec. max., 10 msec. typ.

1.0 INSTALLING THE METER

Installation

The PAX meets NEMA 4X/IP65 requirements when properly installed. The unit is intended to be mounted into an enclosed panel. Prepare the panel cutout to the dimensions shown. Remove the panel latch from the unit. Slide the panel gasket over the rear of the unit to the back of the bezel. The unit should be installed fully assembled. Insert the unit into the panel cutout.

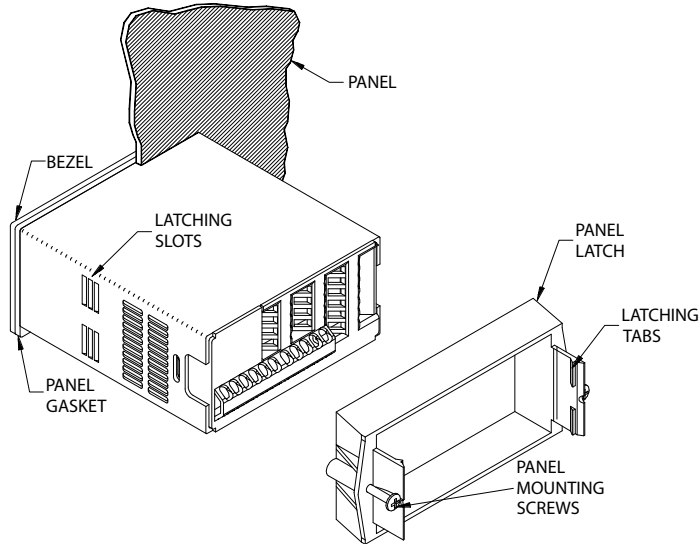

While holding the unit in place, push the panel latch over the rear of the unit so that the tabs of the panel latch engage in the slots on the case. The panel latch should be engaged in the farthest forward slot possible. To achieve a proper seal, tighten the latch screws evenly until the unit is snug in the panel (Torque to approximately 7 in-lbs [79N-cm]). Do not over-tighten the screws.

Installation Environment

The unit should be installed in a location that does not exceed the operating temperature and provides good air circulation. Placing the unit near devices that generate excessive heat should be avoided.

The bezel should only be cleaned with a soft cloth and neutral soap product. Do NOT use solvents. Continuous exposure to direct sunlight may accelerate the aging process of the bezel.

Do not use tools of any kind (screwdrivers, pens, pencils, etc.) to operate the keypad of the unit.

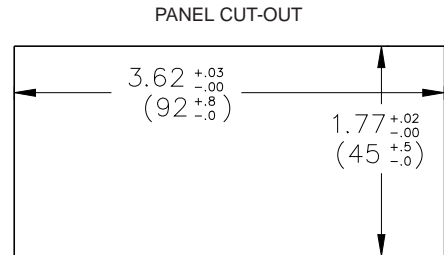

2.0 SETTING THE JUMPER AND DIP SWITCHES

To access the jumper and switches, remove the meter base from the meter case by firmly squeezing and pulling back on the side rear finger tabs. This should lower the latch below the case slot (which is located just in front of the finger tabs). It is recommended to release the latch on one side, then start the other side latch.

2.1 SETTING THE JUMPER

The meter has one jumper for user input logic. When using the user inputs this jumper must be set before applying power. The Main Circuit Board figure shows the location of the jumper and DIP switch.

The user input jumper determines signal logic for the user inputs, when they are used with user functions or for input signal direction. All user inputs are set by this jumper.

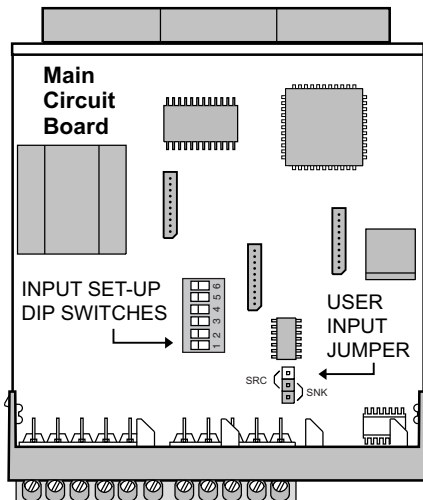

Warning: Exposed line voltage exists on the circuit boards. Remove all power to the meter and load circuits before accessing inside of the meter.

2.2 SETTING THE INPUT DIP SWITCHES

The meter has six DIP switches for Input A and Input B terminal set-up that must be set before applying power. NOTE: The PAXR only uses switches 1-3.

Input B LO Freq.	<input type="checkbox"/>	6	HI Freq.
Input B SRC.	<input type="checkbox"/>	5	SNK.
Input B MAG.	<input type="checkbox"/>	4	Logic
Input A LO Freq.	<input type="checkbox"/>	3	HI Freq.
Input A SRC.	<input type="checkbox"/>	2	SNK.
Input A MAG.	<input type="checkbox"/>	1	Logic
	ON		

■ Factory Setting

SWITCHES 3 and 6

HI Frequency: Removes damping capacitor and allows max. frequency.

LO Frequency: Adds a damping capacitor for switch contact bounce. Also limits input frequency to 50 Hz and input pulse widths to 10 msec.

SWITCHES 2 and 5

SRC.: Adds internal 3.9 K Ω pull-down resistor, 7.3 mA max. @ 28 VDC, V_{MAX} = 30 VDC.

SNK.: Adds internal 7.8 K Ω pull-up resistor to +12 VDC, I_{MAX} = 1.9 mA.

SWITCHES 1 and 4

LOGIC: Input trigger levels V_{IL} = 1.5 V max.; V_{IH} = 3.75 V min.

MAG: 200 mV peak input (must also have SRC on). Not recommended with counting applications.

3.0 INSTALLING PLUG-IN CARDS

The Plug-in cards are separately purchased optional cards that perform specific functions. These cards plug into the main circuit board of the meter. The Plug-in cards have many unique functions when used with the PAX. The literature that comes with these cards should be discarded, unless it specifically states in the Plug-in Card literature that the information applies to the PAX. *Note: The PAXC and PAXR only use the setpoint option card.*



CAUTION: The Plug-in card and main circuit board contain static sensitive components. Before handling the cards, discharge static charges from your body by touching a grounded bare metal object. Ideally, handle the cards at a static controlled clean workstation. Also, only handle the cards by the edges. Dirt, oil or other contaminants that may contact the cards can adversely affect circuit operation.

To Install:

1. With the case open, locate the Plug-in card connector for the card type to be installed. The types are keyed by position with different main circuit board connector locations. When installing the card, hold the meter by the rear terminals and not by the front display board.*
2. Install the Plug-in card by aligning the card terminals with the slot bay in the rear cover. Be sure the connector is fully engaged and the tab on the Plug-in card rests in the alignment slot on the display board.
3. Slide the meter base back into the case. Be sure the rear cover latches fully into the case.
4. Apply the Plug-in card label to the bottom side of the meter in the designated area. Do Not Cover the vents on the top surface of the meter. The surface of the case must be clean for the label to adhere properly.

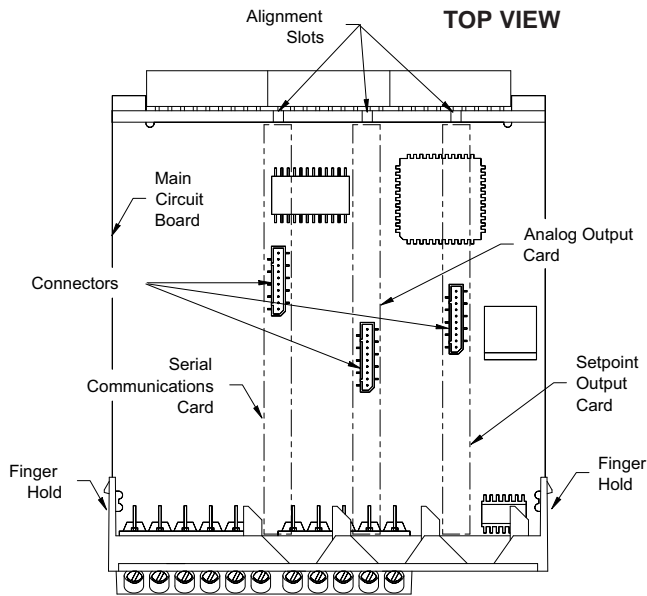

Quad Sourcing Open Collector Output Card Supply Select

* If installing the Quad sourcing Plug-in Card (PAXCDS40), set the jumper for internal or external supply operation before continuing.

